

SITEH3RO™

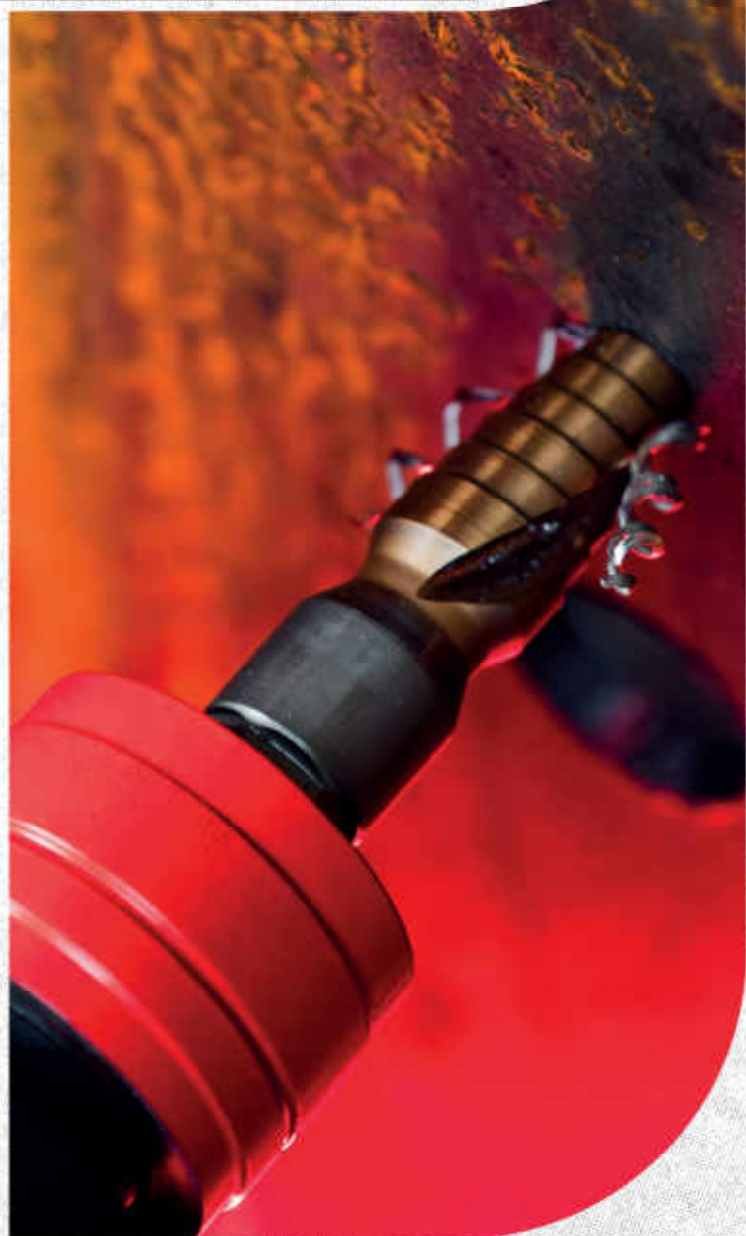
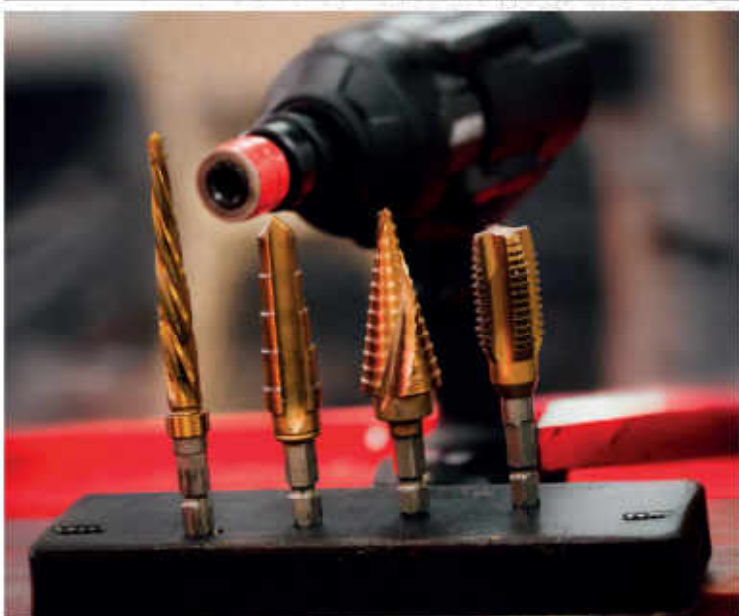

SITEH3RO™

SITEH3RO™

**Turn your Impact
Wrench into a
multipurpose metal
working machine.**



Int. Pat. Pending. WO2024/100390



| 2

ROTABROACH.CO.UK

Connect Click **GO**

Turn your Impact Wrench into a multipurpose metal working machine.

1. Connect

Connect the holder to the Impact Wrench

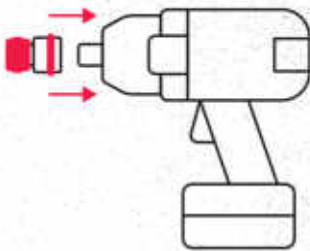

2. Click

Insert the tool

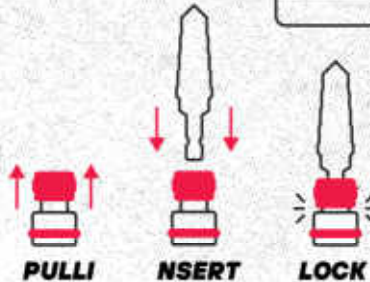
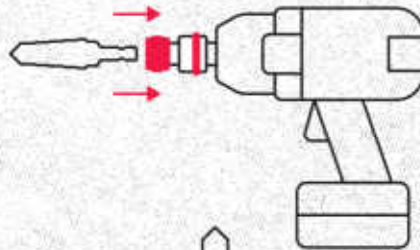

3. GO

Start DRILLING!

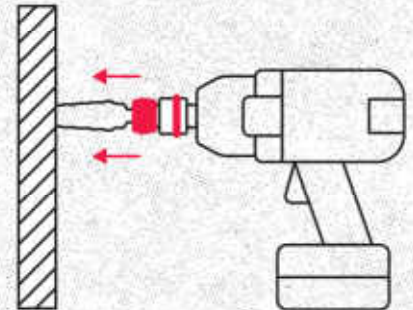

ALIGN HOLES



EXPAND HOLES



THREAD HOLES



NEW HOLES



Drill new, expand, thread and align holes for the major diameters

SMOOTH, EASY CUT

75%
Longer life with SITEH3RO™ coating

Suitable for 1/2" and 3/4" Impact Wrenches (holder dependent)

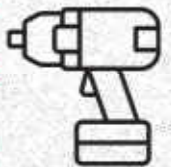

Make **NEW HOLES** with Step Drills & Step Reamers



ALIGN HOLES with Car Reamers



THREAD HOLES with Taps



EXPAND HOLES with Step Drills and Step & Car Reamers



SITEH3RO™: Holder

SITEH3RO™

SITEH3RO™ HOLDER

Int. Pat. Pending. WO2024/100390

Suitable
for 1/2" and
3/4" Impact
Wrenches

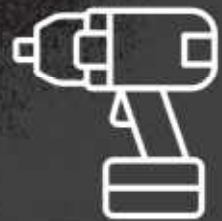

High
Temperature
Tested to
180°C



Quick
Release

SITEH3RO™ Holder Sizes:

Part Number	Description	Size	Impact Wrench
RSH12	1/2" Square Holder	1/2"	1/2" Impact Wrench
RSH34	3/4" Square Holder	3/4"	3/4" Impact Wrench

Turn your Impact
Wrench into a
multipurpose metal
working machine.

1. Connect

Connect the holder to
the Impact Wrench

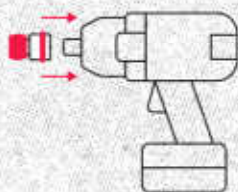

2. Click

Insert the tool

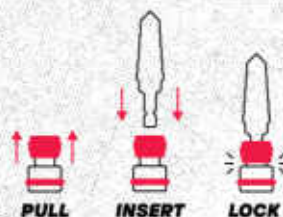
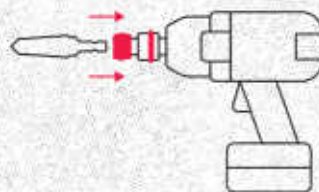

3. GO

Start DRILLING!

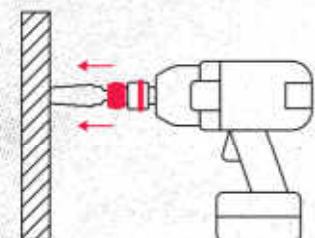

SITEH3RO™: Car Reamer

SITEH3RO™

CAR REAMER

Spiral Flute for
Faster Cuts

SITEH3RO™
Coating

Safety Collar

7/16" Hex
Impact Shank



- Align, clean out and expand holes on site with your Impact Wrench and SITEH3RO™
- High performance coating for up to 75% longer tool life
- Available in 18 major diameter sizes
- Suitable for use in standard 3-jaw drill chucks
- Smooth, easy cut

CAR REAMER Sizes:

Part Number	Diameter	Shank
CR08	8mm	7/16" Hex Impact Shank
CR10	10mm	
CR11	11mm	
CR12	12mm	
CR13	13mm	
CR14	14mm	
CR15	15mm	
CR16	16mm	
CR17	17mm	
CR18	18mm	
CR19	19mm	
CR20	20mm	
CR21	21mm	
CR22	22mm	
CR23	23mm	
CR24	24mm	
CR25	25mm	
CR26	26mm	

CAR REAMER Kits:

Part Number	Size Range	Kit Description
SHRCR1	14, 18, 22mm	3 Piece Kit
SHRCR2	12, 14, 18, 22 & 26mm	5 Piece Kit
SHRCR3	8, 10, 12, 14, 16, 18, 20, 22, 24, 26mm	10 Piece Kit

75%

Longer life with
SITEH3RO™ coating

Suitable for
1/2" and
3/4" Impact
Wrenches
(holder
dependent)

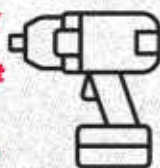

**ALIGN
HOLES**



**EXPAND
HOLES**



SITEH3RO™: Step Reamer

SITEH3RO™

STEP REAMER

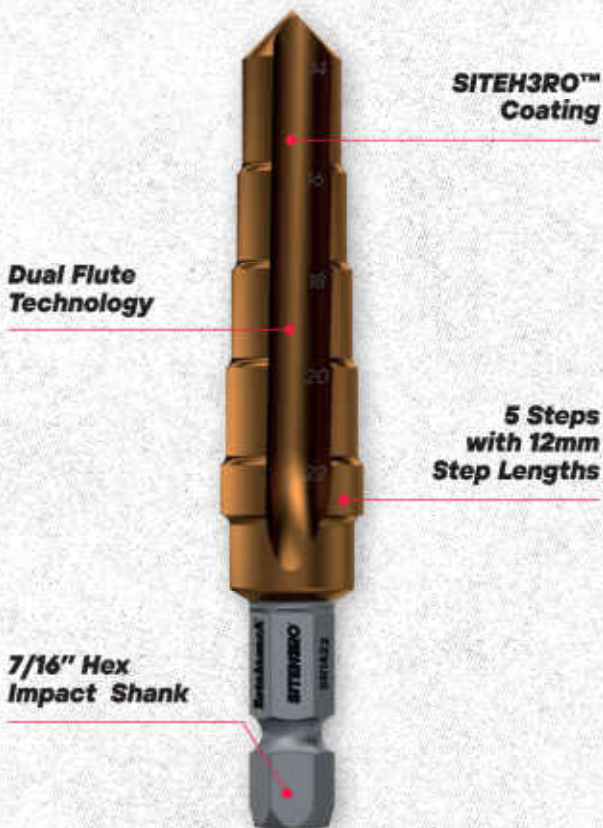

- Expand and clean out holes with your Impact Wrench
- 3 tools allow you to expand and clean out holes across 15 sizes from 8mm to 28mm in up to 12mm thick material
- Ideal for expanding holes and available in all major bolt sizes
- High performance coating, providing up to 75% longer tool life
- Suitable for use in standard 3-jaw drill chucks

STEP REAMER Sizes:

Part Number	Diameter	Shank
SR816	8mm to 16mm	7/16" Hex Impact Shank
SR1422	14mm to 22mm	
SR2028	20mm to 28mm	

All STEP REAMERS include 5 steps with 12mm Step Lengths.

STEP REAMER Kit:

Part Number	Diameter	Shank
SHRSR1	8mm to 16mm 14mm to 22mm 20mm to 28mm	7/16" Hex Impact Shank

75%

Longer life with SITEH3RO™ coating

Suitable for 1/2" and 3/4" Impact Wrenches (holder dependent)

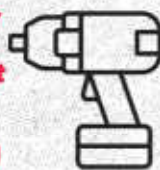

NEW HOLES

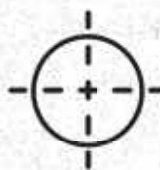

EXPAND HOLES



SITEH3RO™: Step Drill

SITEH3RO™

STEP DRILL

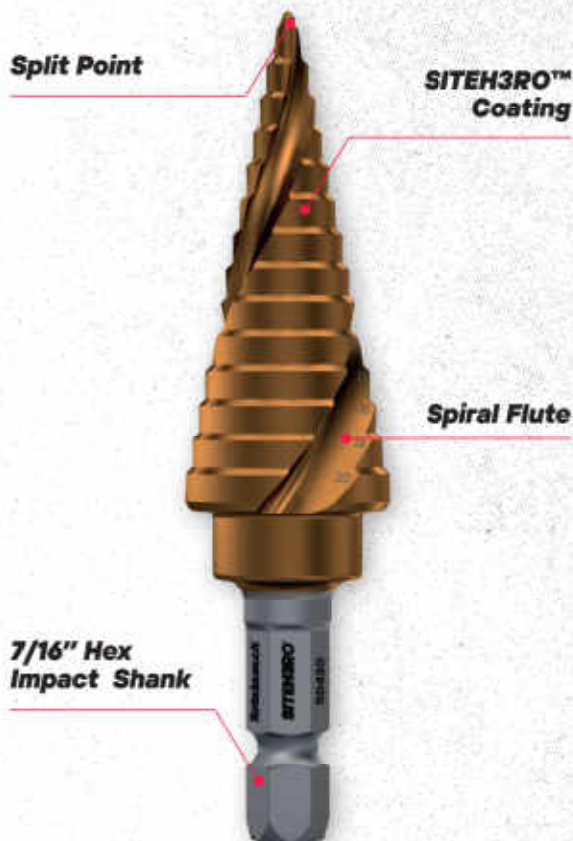

- Drill new holes and expand thin gauge material with an Impact Wrench and SITEH3RO™
- Utilise in SITEH3RO™ holders for Impact Wrenches or any standard drill chuck
- Holes from 4mm to 30mm in diameter, each step 5mm
- High performance coating for up to 75% longer tool life
- Suitable for use in standard 3-jaw drill chucks

STEP DRILL Sizes:

Part Number	Diameter	Shank
SD412	4mm to 12mm	7/16" Hex Impact Shank
SD420	4mm to 20mm	
SD430	4mm to 30mm	

All STEP DRILLS include a spiral flute with a 118° point.

STEP DRILL Kit:

Part Number	Diameter	Shank
SHRSD1	4mm to 12mm 4mm to 20mm 4mm to 30mm	7/16" Hex Impact Shank

75%

Longer life with SITEH3RO™ coating

Suitable for 1/2" and 3/4" Impact Wrenches (holder dependent)

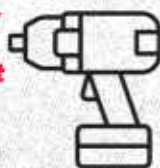

NEW HOLES

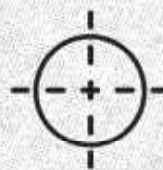

EXPAND HOLES



SITEH3RO™: Taps

SITEH3RO™

TAPS

- **Spiral Point Machine Tap : One Tap Solution**
- **Thread holes with your Impact Wrench – up to 20 X faster than hand tapping**
- **High performance coating for up to 75% longer tool life**
- **Thread holes from M5 to M30**
- **Tap holes in material up to 25mm deep**
- **Available in 12 major sizes**

Spiral Point
Machine Tap



SITEH3RO™
Coating

7/16" Hex
Impact Shank

TAP Sizes:

Part Number	Diameter	Shank
TPM5	M5 x 0.80	7/16" Hex Impact Shank
TPM6	M6 x 1.00	
TPM8	M8 x 1.25	
TPM10	M10 x 1.50	
TPM12	M12 x 1.75	
TPM14	M14 x 2.00	
TPM16	M16 x 2.00	
TPM18	M18 x 2.50	
TPM20	M20 x 2.50	
TPM24	M24 x 3.00	
TPM27	M27 x 3.00	
TPM30	M30 x 3.50	

TAP Kits:

Part Number	Diameter	Kit
SHRTP1	M6, M8, M10, M12, M16	5 Piece Kit
SHRTP2	M12, M16, M20, M24	4 Piece Kit
SHRTP3	M5, M6, M8, M10, M12, M14, M16, M18, M20, M24, M27, M30	12 Piece Kit

75%
Longer life with
SITEH3RO™ coating

Suitable for
1/2" and
3/4" Impact
Wrenches
(holder
dependent)

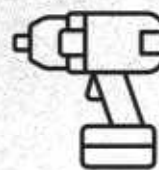

**THREAD
HOLES**

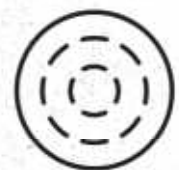

SITEH3RO™: Kits

SITEH3RO™

KITS



- Align, Thread, Expand and Drill New Holes
- SITEH3RO™ kit solutions for all major applications
- Multiple kit sizes available per tool type

SITEH3RO™ Ultimate Kit:

Part Number	Tool Type	Diameter	Qty
SHR1	Step Drills	4-12mm / 4-20mm / 4-30mm	3
	Step Reamers	8-16mm / 14-22mm / 20-28mm	3
	Taps	M6, M8, M10 & M12	4
	Car Reamers	14mm / 18mm & 22mm	3
	Holder	1/2" & 3/4"	2

CAR REAMER Kits:

Part Number	Size Range	Kit Description
SHRCR1	14, 18, 22mm	3 Piece Kit
SHRCR2	12, 14, 18, 22 & 26mm	5 Piece Kit
SHRCR3	8, 10, 12, 14, 16, 18, 20, 22, 24, 26mm	10 Piece Kit

STEP REAMER Kit:

Part Number	Diameter	Shank
SHRSR1	8mm to 16mm 14mm to 22mm 20mm to 28mm	7/16" Hex Impact Shank

STEP DRILL Kit:

Part Number	Diameter	Shank
SHRSD1	4mm to 12mm 4mm to 20mm 4mm to 30mm	7/16" Hex Impact Shank

TAP Kits:

Part Number	Diameter	Kit
SHRTP1	M6, M8, M10, M12, M16	5 Piece Kit
SHRTP2	M12, M16, M20, M24	4 Piece Kit
SHRTP3	M5, M6, M8, M10, M12, M16, M20, M24, M30	9 Piece Kit

75%

Longer life with SITEH3RO™ coating

Suitable for 1/2" and 3/4" Impact Wrenches (holder dependent)

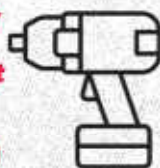

NEW HOLES



EXPAND HOLES



THREAD HOLES



ALIGN HOLES

POWER To Cut Metal.



Rotabroach

POWER To Cut Metal.

SITEH3RO™

15 PIECE SET

- 2 X SITEHERO HOLDERS - 1/2" & 3/4"
- 3 X STEP DRILLS - 4-12mm, 4-20mm, 4-30mm
- 3 X CAR REAMERS - 14mm, 18mm, 22mm
- 3 X STEP REAMERS - 6-16mm, 14-22mm, 20-28mm
- 4 X TAPS - M6, M8, M10, M12

Drill new, expand, thread and align holes for the major diameters

75%

Longer life with SITEH3RO coating

SMOOTH, EASY CUT



Available for 1/2" and 3/4" Impact Wrenches*

*Machine dependent

Makes NEW HOLES with Step Drills & Step Reamers

ALIAS HOLES with Car Reamers

THREAD HOLES with Taps

EXPAND HOLES with Step Drills and Step & Car Reamers



STEP DRILLS

STEP REAMERS

CAR REAMERS

TAPS



**Turn your Impact Wrench into a multipurpose metal working machine.
Connect Click GO**

POWER To Cut Metal.™

Rotabroach

BURGESS ROAD, SHEFFIELD S9 3WD

TEL: +44 (0)114 221 2510

EMAIL: SALES@OSLCT.CO.UK

WEB: ROTABROACH.CO.UK

ROTABROACH.CO.UK

